

Media: air
 Pressure range: 0 to 9 Bar max
 Media temp: -10°C +60°C max
 Ambient temperature: -10° to +60°C
 Mounting: any position

4/2 4/3 Hand Control

1/4 3/8 1/2

Mechanical Valves

4 WAY DIRECT ACTING

0 – 9 Bar

TYPE TSV30043/42







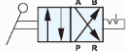



TSV30043

TSV30042

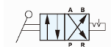

PRESSURE

Ø Port	Ø Orifice (mm²)	Pressure Rating (Bar)		Function	Valve type	Picture	Part Number
		Min	Max				
1/4 (02)	18mm²	0	9	4/3 Way TSV30043 	Standard		TSV30043 + port
		0	9		Ports in base		TSV30043 + port + B
		0	9		With lock button		TSV30043 + port + C
		0	9		Panel mounted		TSV30043 + port + P
3/8 (03)	18mm²	0	9	4/2 way TSV30042 	Standard		TSV30042 + port
		0	9		Ports in base		TSV30042 + port + B
		0	9		With lock button		TSV30042 + port + C
		0	9		Panel mounted		TSV30042 + port + P

OPTIONS

NPT Thread (TSV30043 +port +N)

CONSTRUCTION

Body : Aluminium alloy, Panel dimension 30mm, internal parts : Stainless steel, Seals and gaskets : NBR
 Test pressure: 10 Bar

OVERALL DIMENSIONS

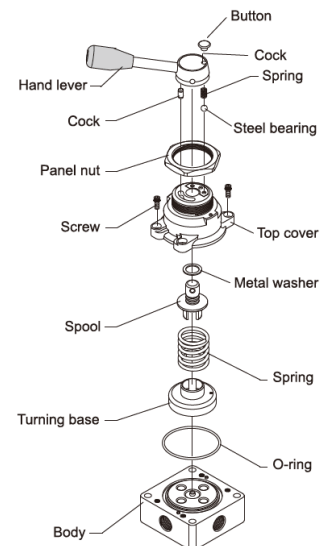
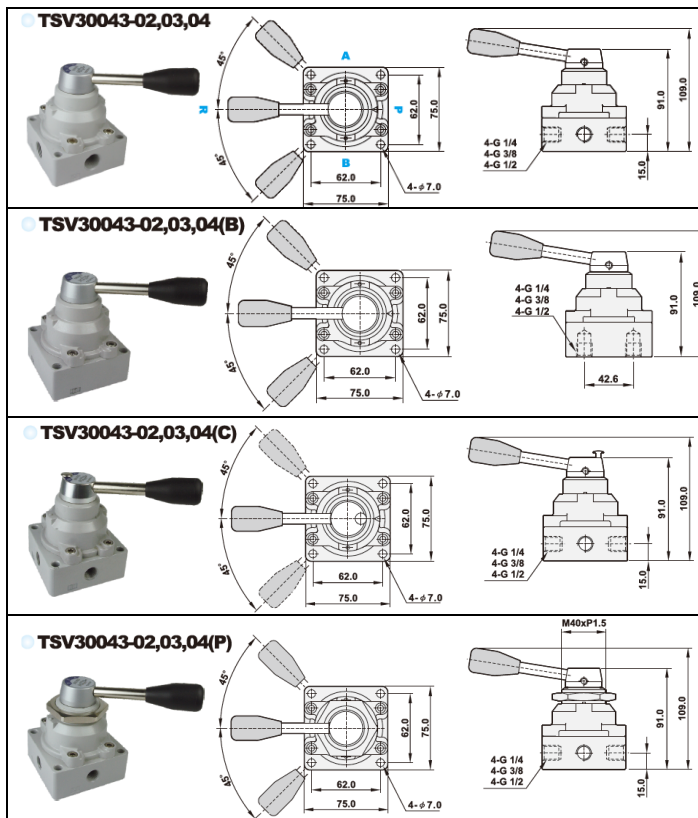

Model: TSV30043-02, 03, 04

