

Symbol

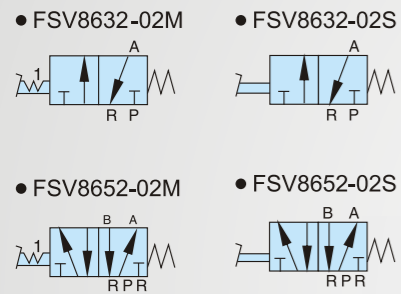

Features

- * Aluminum alloy construction for durable use.
- * Available to be installed with polycarbonate protective guard.

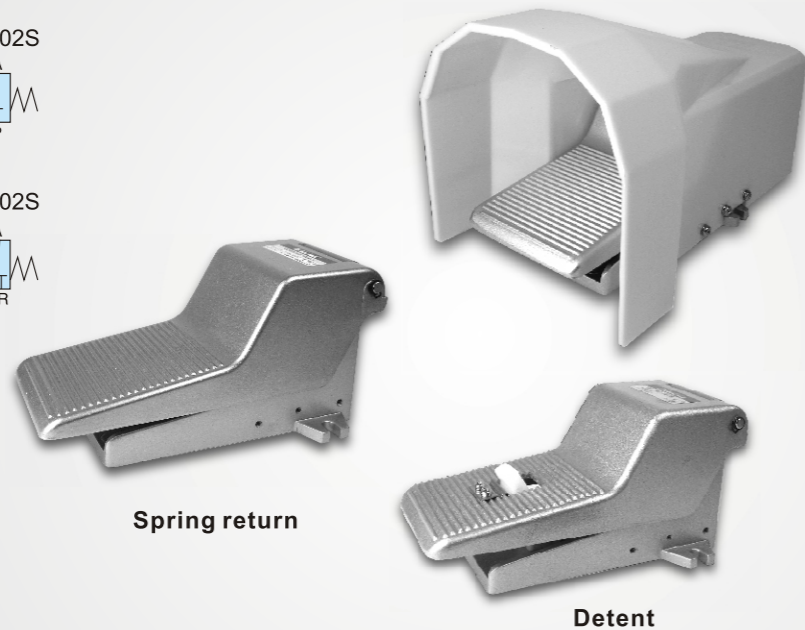

How to order

| | | | | | |
|-------------------|---------|-----------|----------|-----------------|------------------|
| FSV8632 | - | 02 | N | M | F |
| Foot pedal valves | | Port size | Thread | Acting | Protective guard |
| FSV8652 | 5/2 way | 02 1/4" | Blank G | S Spring return | Blank W/O guard |
| FSV8632 | 3/2 way | | N NPT | M Detent | F W/I guard |

Flow chart

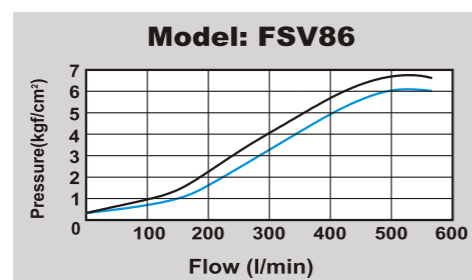

Specifications

| Model | FSV8632-02 | FSV8652-02 |
|--------------------------|---------------------------|------------|
| Port size | 1/4" | |
| Body material | Aluminum alloy | |
| Fluid | Compressed air | |
| Sectional area | 12mm ² | |
| Operating pressure range | 0 ~ 9 kgf/cm ² | |
| Proof pressure | 10 kgf/cm ² | |
| Ambient temperature | -10°C ~ 60°C | |

Dimensions

- FSV8652-02M(S)
- FSV8632-02M(S)

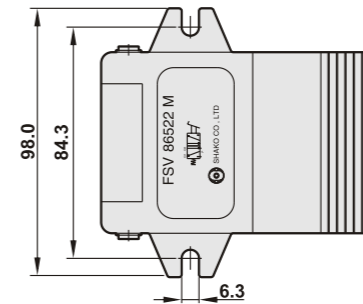

Detent

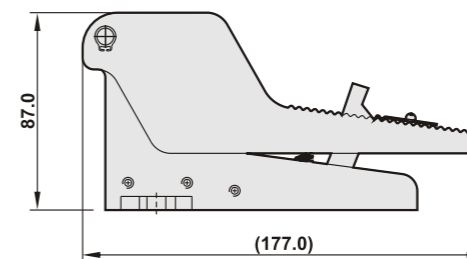
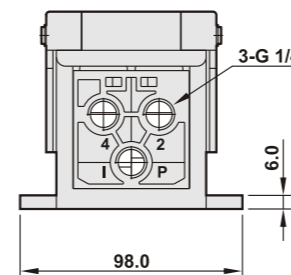

Spring return

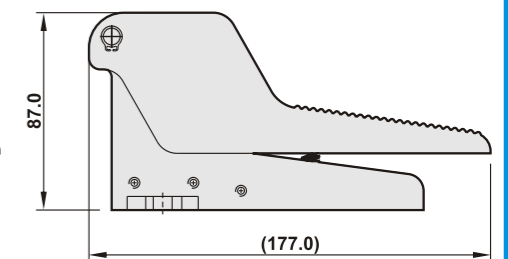

Guard dimensions

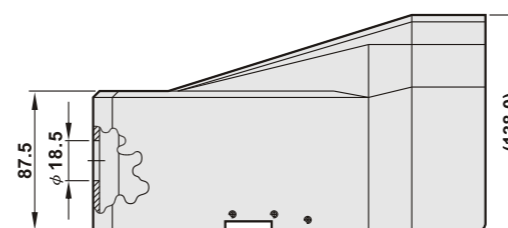
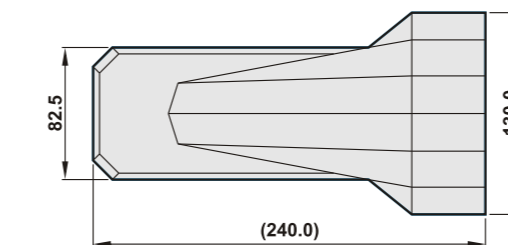

Explosion

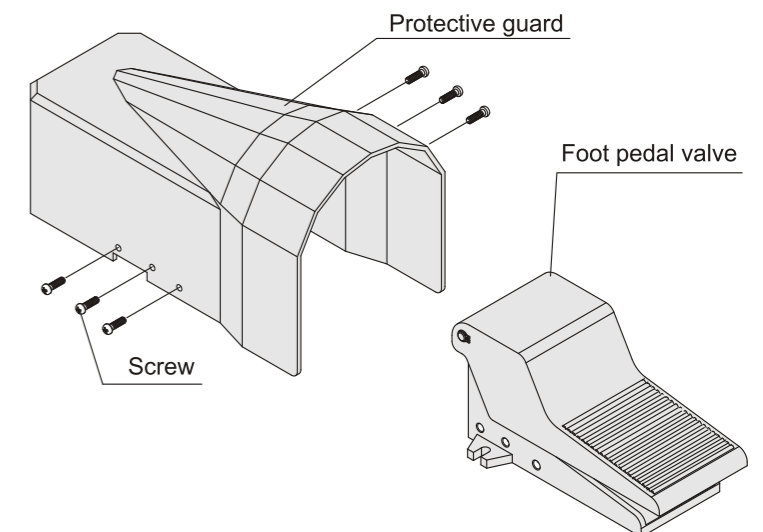

MECHANICAL VALVES

MECHANICAL VALVES